

# **HYDRAULIC BRAKE SYSTEMS AND COMPONENTS FOR OFF-HIGHWAY VEHICLES AND EQUIPMENT**

**David E. Keyser  
Applications Coordinator**

**Keith Hogan  
OEM Sales**

**MICO, Inc.  
1911 Lee Boulevard  
North Mankato, MN U.S.A. 56003-2507  
Fax: +1 507 625 3212  
Tel: +1 507 625 6426**

## ABSTRACT

This paper will identify some prerequisites for brake actuation circuit design, describe three basic types of brake actuation circuitry, and will point out some common problems to be avoided in brake actuation circuit design for off-highway vehicles and equipment. It will deal only with the actuation of service brakes (as opposed to parking brake). Service brake selection, pneumatic, and vacuum powered brake systems are beyond the scope of this paper.

## PREREQUISITES

Although we are assuming fully functional and operational brakes, this paper outlines six key prerequisites that need to be known in order to design the brake actuation circuit. These are: (1) stopping parameters, (2) required brake torque, (3) capacity of the service brakes, (4) brake line pressure, (5) volumetric requirements, and (6) required operator input effort. Because there are many brake actuation circuits possible for a given application, this information must be understood in order for the designer to choose the optimal circuit.

In selecting the components for a brake actuation circuit the designer needs to start at the foundation (service) brakes and "work backward" to the method of actuation. By working backward the designer avoids the pitfall described below under the heading "Service Brake Capacity".

### Stopping Parameters

The stopping parameters include deceleration rate, stopping distance, percentage of grade for operation, and vehicle speed. The desired stopping parameters, are used to determine the required brake torque. They can be sourced from one of several publications, such as the Society of Automotive Engineers (SAE), the International Standards Organization (ISO), Federal, State, Provincial Government agencies or specified by the vehicle designer.

### Brake Torque Requirement

The torque required to stop the vehicle within the desired parameters can be calculated with the assistance of DESIGNING THE BRAKE SYSTEM STEP BY STEP, a 1976 SAE publication, 760637, by Fred W. Cords and John B. Dale, and MECHANICS OF VEHICLES, a 1957 Pento Publishing Co. publication by Jaroslav J. Taborek.

### Service Brake Capacity

The service brake capacity is expressed as the torque at a given brake line pressure and is generally a linear function. This information is acquired from the brake and or axle manufacturer.

To avoid the pitfalls of either underbraking or overbraking it is important to calculate the actual required torque for the application. **Do not assume** that the manufacturer's specified maximum brake line pressure is the same as the required brake line pressure.

This can be demonstrated in the following examples in which the brake torque **requirement** is above then below the torque capability of the service brake.

Consider a vehicle that requires 680 N·m of brake torque. The torque capability of the service brakes is 450 N·m at a **maximum pressure** of 70 bar. Supplying the maximum 70 bar does not stop the vehicle as required, the vehicle is underbraked.

Conversely, consider the torque requirement is now 110 N·m and the brake is still rated at 450 N·m and 70 bar. Supplying the 70 bar will stop the vehicle immediately (too severely). The torque requirement is satisfied with 25% of the available pressure resulting in aggressive, over sensitive brakes.

These scenarios will change in magnitude depending on the style of actuation that you select. Through proper brake actuation and circuit design one can match the circuit to the service brakes and avoid poor performance characteristics such as these.

### Brake Line Pressure

The brake line pressure is determined by the brake torque requirement and the service brake capacity. By establishing how much torque is developed at a given pressure, brake torque can be expressed as brake line pressure.

### Required Volume

The volume requirement is critical in determining the type of system to be used. The designer needs to know the minimum, nominal, and maximum volume of fluid required. Different types of actuation operate in different ranges of volumetric displacements.

## Input Pedal Force

Input pedal force is generally expressed as a maximum force allowed to generate the desired maximum brake line pressure. Again, there are governing agencies that make recommendations to assist in identifying this value.

## **BRAKE ACTUATION CIRCUITS**

The system designer can accomplish brake actuation in different ways. The use of a direct means of actuation, such as hydraulic pressure to apply the brakes is but one method of brake actuation. Another type of actuation is reverse modulation or negative braking as it is referred to in the European community. Reverse modulation uses hydraulic pressure to release a spring apply brake. Maximum torque is produced when hydraulic pressure is absent either intentionally or due to system failure. The subject of reverse modulation requires further detailed explanation beyond the scope of this paper. Also beyond the scope of this paper are pneumatic and vacuum boosted hydraulic circuits as it is felt that the trend is clearly away from them toward full hydraulic circuits. This paper will discuss three broad categories of hydraulic pressure actuation circuits, these are:

- Non-Boosted Brake Circuits
- Boosted Brake Circuits
- Full Power Hydraulic Brake Systems

## **NON-BOOSTED BRAKE CIRCUITS**

These systems are manually actuated without the benefit of a power assist such as air, hydraulic or vacuum.

### Straight Bore Master Cylinders

The Single Piston Straight Bore type Master Cylinder has been a brake system component since the early 1930's and is still in extensive use. The main components of such a cylinder can be identified as the cylinder bore and piston (A), seals (B), fluid reservoir (C), and push rod (D), see Figure 1.

With the brake completely released (no input force on brake pedal), the cylinder is at reservoir or atmospheric pressure. As force is applied to the brake pedal, the push rod, through pedal linkage, is forced forward in the cylinder bore. The primary cup seal, which is ahead of the piston, is forced down the

cylinder bore closing off the compensating port, see Figure 1 (E). This completely seals the hydraulic system.

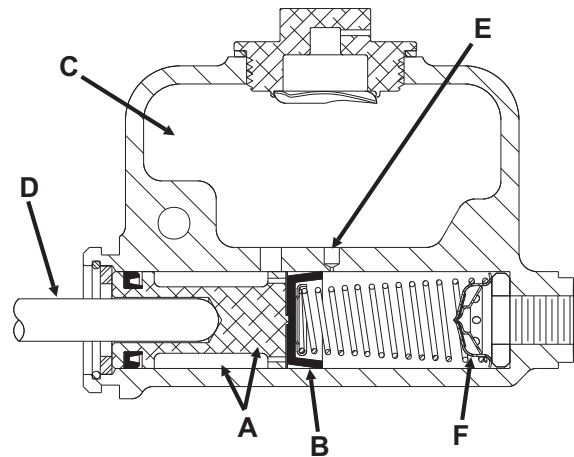

Figure 1 Straight Bore Master Cylinder

Any additional force on the push rod will now cause an increase in load induced fluid pressure. The increased pressure and transfer of fluid is then transmitted to the brake. Releasing the force on the brake pedal allows fluid to flow back to the cylinder bore and ultimately to the reservoir.

The residual valve Figure 1 (F), if used, maintains pressure of 1-2 bar in the brake lines when the pedal is released.

In drum brake systems this low pressure aids in preventing air from entering the brakes when the vehicle is at rest. The residual valve is removed from models designed for disc brake systems because of the drag which would develop in this type of brake, even at these relatively low pressures.

The advantages of this type of actuation is they are inexpensive and simple. They are available for use with automotive type brake fluid or mineral base hydraulic oil. On vehicles that use non-self-adjusting drum and shoe type brakes, as the brakes wear the need for servicing is indicated by the pedal position when actuated.

### Considerations

Some consideration must be given to the fact that these circuits are limited in fluid displacement and operating pressure. Therefore, these systems should generally be considered for low volume requirement, and system pressures. However, if the volumetric requirement is too small this style of actuator can suffer

short component life due to cup cutting. If the brakes have a low volumetric requirement they will fill quickly and thus come to pressure quickly, often before the primary cup has passed the compensating port. This action causes the primary cup to be forced into the compensating port causing cup cutting as continued piston travel occurs.

In addition, because the operator actuates these cylinders through the mechanical advantage of a pedal and linkage arrangement, and in the absence of relief protection, the increased pedal effort can cause an over pressure condition during panic stop conditions.

These systems will consist of the straight bore master cylinder (1) actuated through an actuating mechanism (2) and the brakes (3), see Figure 2.

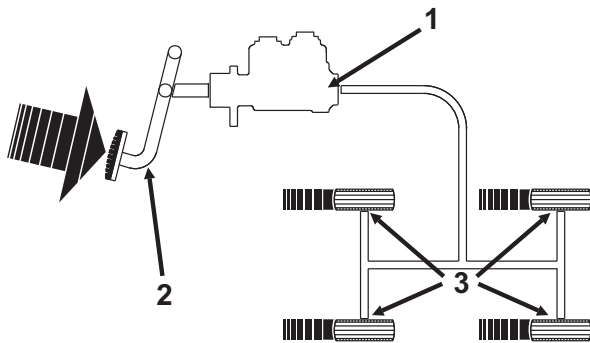

Figure 2 Simple Non-Boosted Brake System

### Power Cylinders

Through the years, larger brakes began to demand combinations of larger volumes and higher pressures than were capable from straight bore master cylinders. The power cylinder was designed to meet these demands without the use of an external power source.

The power cylinder incorporates two pistons concentric within one housing. The large piston provides the fluid volume necessary to fill the brakes while the small bore produces the pressure for operation.

Transfer from the volume piston to the pressure piston is accomplished by means of an internal metered pressure relief valve.

As shown in Figure 3, the main components of the power cylinder are the **high volume** bore and piston (A), **high pressure** bore and piston (B), relief valve (C), reservoir (D), and push rod (E). With the cylinder at rest, the relief valve is closed and both bores are open to reservoir or atmospheric pressure. As force is applied to the push rod, the **high volume** cup passes the compensating port (F) sealing the brake system from the reservoir. Continued pedal movement begins to pressurize both cylinder bores as fluid is forced out to the brakes. Displacement from the **high volume** bore continues until the load induced pressure is greater than the relief valve pressure setting. At this

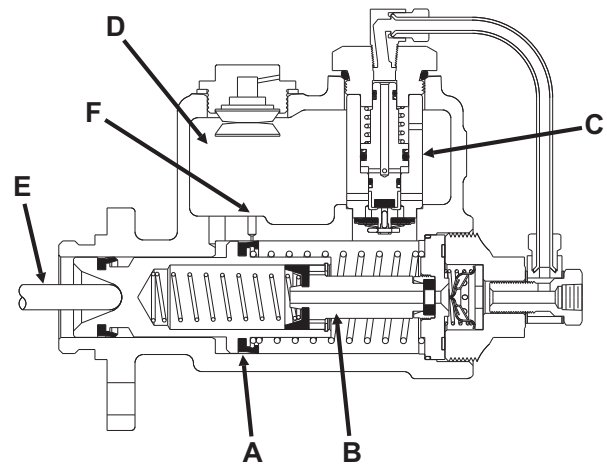

Figure 3 Power Cylinder

time the relief valve opens allowing the fluid in the **high volume** bore to flow directly to reservoir. This pressure drop in the **high volume** bore isolates the **high pressure** bore and further cylinder displacement continues from the **high pressure** bore only. As the relief valve opens, it is common for the operator to feel the transfer from the low pressure to the high pressure bore through the brake pedal. Releasing the force on the brake pedal closes the relief valve and allows fluid to flow back to the cylinder bore. The compensating port then provides the fluid necessary to compensate for lining wear.

The power cylinder provides the advantage of higher pressure in systems without the added cost of a boosted system. They are available in both D.O.T. brake fluid and mineral base hydraulic oil models.

## Considerations

Since each brake system is different, it is difficult to determine at which point during the stroke of the cylinder the relief valve opens. Therefore, power cylinders provide a range of fluid displacements. It is important to determine the lower pressure "fill" volume as well as total volume at maximum braking pressure prior to making a cylinder selection.

Fluid viscosity and line size must also be considered. A high viscosity fluid or small line sizes may result in excess pressure drop causing the relief valve to open prematurely. A common misconception about the power cylinder is the function of its internal relief valve. The relief valve does not limit maximum output pressure. Pressure is only limited by input force on the push rod. Therefore, great care should be taken to select a cylinder that best fits the pedal effort and pressure requirements.

## BOOSTED BRAKE CIRCUITS

Boosted brake circuits are those systems where the brake actuation effort is assisted by hydraulic, air, or vacuum.

### Open Center Hydraulic Power Brake Valve

The open center power brake valve will provide hydraulic power braking when installed in an open center hydraulic system. It can be used in the same circuit as other hydraulic devices such as power steering, see Figure 4. Using a single pump to provide flow and pressure, the brake valve should be installed, in series, between the pump relief valve and the other hydraulic devices. The entire hydraulic pump flow is directed through the brake valve and is available to actuate the downstream devices. The brake valve requires a very small volume of oil for its operation. Consequently, it does not interfere with the rest of the system, nor does the usual actuation of downstream hydraulic devices affect operation of the brake valve. Full system pressure is always available for operating the rest of the system. This valve reduces the braking effort to any required degree depending on the pedal ratio. The reactive brake pedal force is directly proportional to brake line pressure, thus giving a sense of feel in the operation of the brakes.

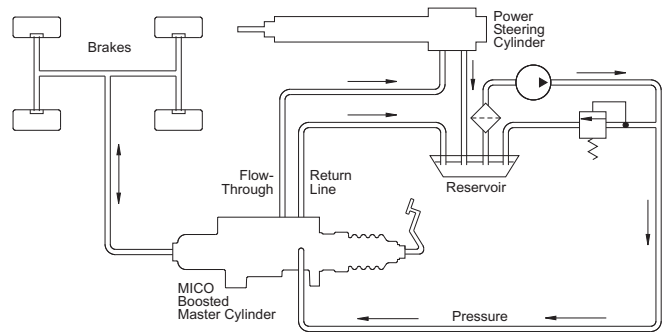

Figure 4 Open Center Power Brake System Typical Circuit

## Considerations

The valve uses the system's hydraulic oil to operate the brakes. Therefore, it should only be considered when using brakes compatible with hydraulic oil. A mechanical follow through allows for manual braking whenever the hydraulic power system is not functioning. However, a significantly longer pedal stroke, usually with increased pedal effort, will be expected when braking in this condition. Therefore, proper attention should be given to the space required for this increased pedal stroke during power off braking. Figure 5 shows a cross section of an open center power brake valve.

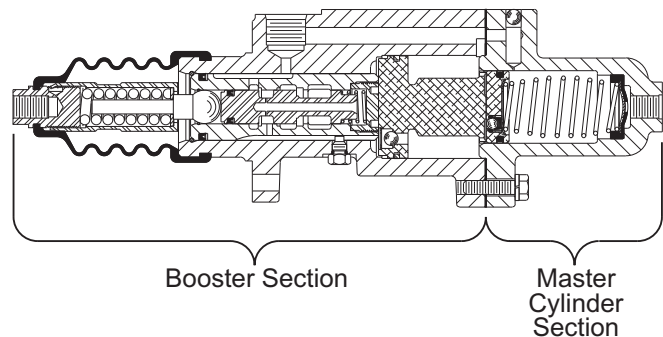

Figure 5 Open Center Power Brake Valve

### Two Fluid Power Brake Actuators

Two fluid power brake actuators permit the addition of a power braking system to vehicles that are equipped with other hydraulic devices. They combine a booster section with a master cylinder section in a single unit. The term "two fluid" comes from their ability to utilize two different types of fluid simultaneously. This feature enables the booster section to be powered with an

existing mineral base hydraulic oil circuit while maintaining the use of D.O.T. brake fluid in the rest of the brake system. To better understand the two fluid brake actuator the two main sections, booster and master cylinder, will be discussed.

Open center boosters are hydraulic assisted devices that provide the mechanical force to operate the master cylinder section, see Figure 6. With the brakes released, fluid from the hydraulic power system flows freely from the inlet, across the metering lands, (A) to the outlet. Actuation causes this flow to become partially restricted, developing a pressure differential across piston (C). As input piston (B) travels inward, additional restriction causes greater hydraulic pressure differential across piston (C). This additional pressure differential advances piston (D) and advances the

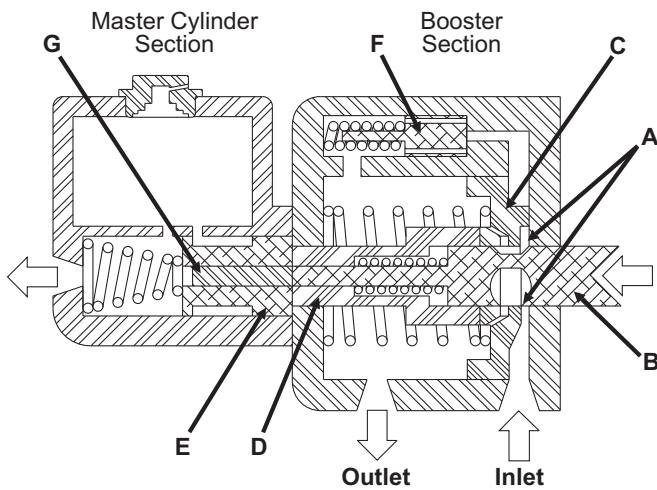

Figure 6 Two Fluid Power Brake Actuator

master cylinder piston (E). When the differential pressure reaches the setting of relief valve (F) maximum boosted pressure has been achieved. If booster pressure is lost, brake line pressure is then determined by pedal effort, pedal ratio and master cylinder bore diameter. A longer pedal stroke, usually with increased pedal effort will be expected when braking in this condition.

The master cylinder section may be either a straight bore, power cylinder, or tandem configuration. Most configurations contains an internal reaction piston, Figure 6 item (G). During actuation, this piston is forced back against the booster input piston, Figure 6 item (B), generating a force proportional to the brake

line pressure. This hydraulic feedback, which is called the reactive pedal force, gives the operator pedal "feel".

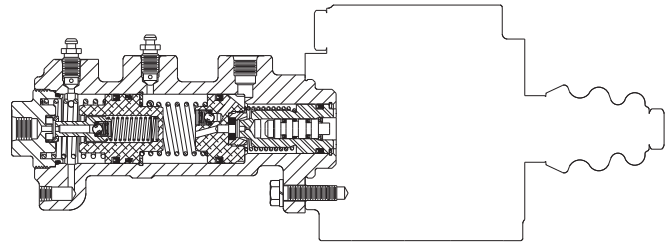

Figure 7 Two Fluid Tandem Master Cylinder

The straight bore and power cylinder sections operate as described earlier in this text. The tandem cylinder, Figure 8, incorporates two independent master cylinder sections in one housing. These are typically used in "split" brake circuits. These are circuits that have two independent halves. By dividing one system into two separate systems, the tandem master cylinder provides a backup in the event either half should become inoperable. They were initially developed due to regulations governing brake systems for highway vehicles. However, their popularity continues to grow in many off-road vehicle markets.

### Considerations

The two fluid booster relies completely on fluid flow to create the differential pressure needed to maintain power boost. This point must be considered when designing a system with power beyond capabilities. When dealing with a power beyond system, it is necessary to include a second relief valve between the two fluid actuator and the device downstream, as shown in Figure 8. The purpose of this relief is to

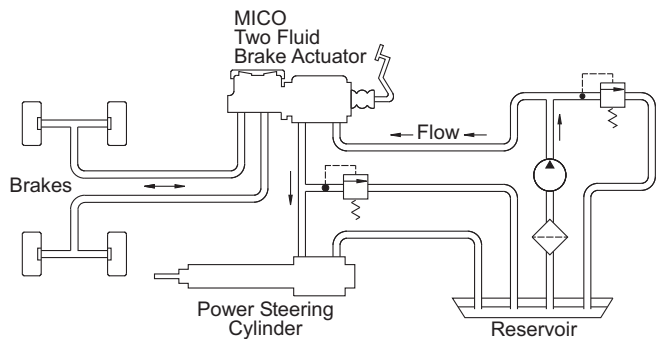

Figure 8 Open Center Two Fluid Hydraulic Brake System Typical Circuit

ensure continuous flow through the valve. Without this relief, it is possible for the downstream device to open the main relief and divert all flow to tank.

When considering a two fluid power brake actuator, it is important to remember that the brake system depends on the limited volume supplied by the master cylinder section.

### FULL POWER HYDRAULIC BRAKE SYSTEMS

The full power hydraulic brake system has several advantages over the systems that have previously been discussed. These systems are capable of supplying fluid to a range of very small and large volume service brakes with actuation that is faster than air brake systems. Figures 9 and 10 represent a time comparison between a typical air/hydraulic and full power hydraulic brake system.

Full power systems can supply significantly higher brake pressures with relatively low reactive pedal forces, while controlling the maximum brake line pressure. The brake valves that are used will typically provide very good brake pressure modulation. This means that the reactive pedal force felt by the operator will be proportional to the brake line pressure being generated. Internal valve components such as;

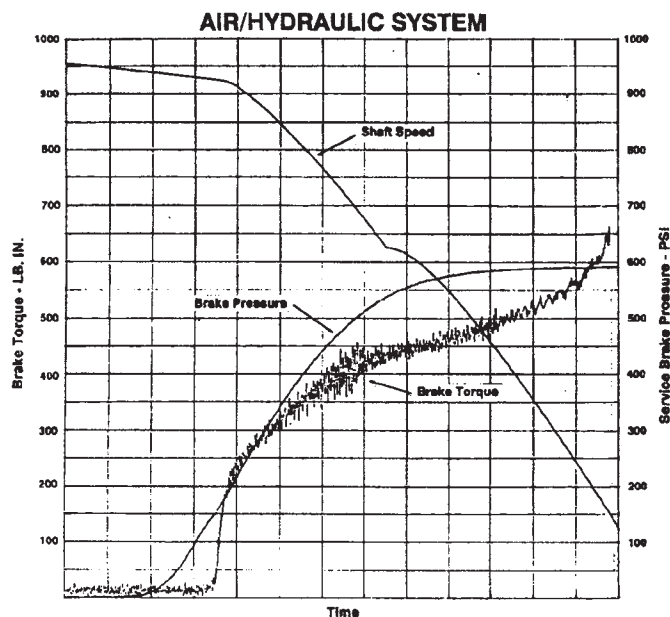

Figure 9 Time Response - Air/Hydraulic

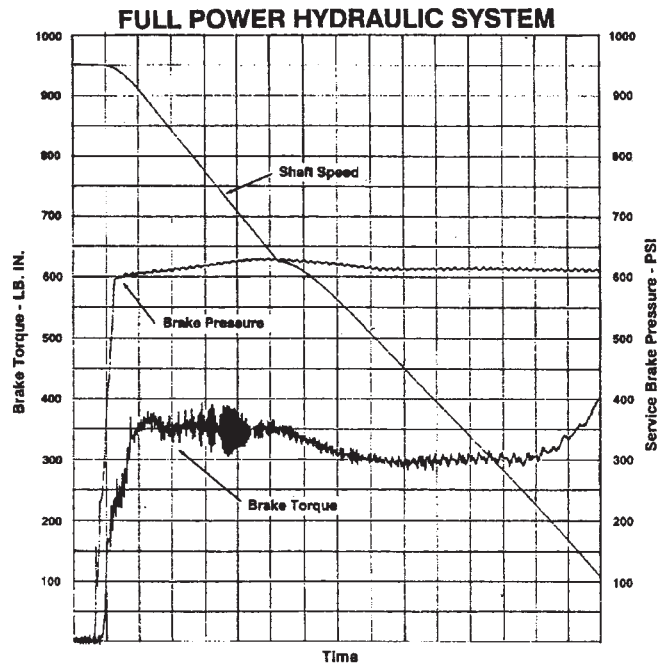

Figure 10 Time Response - Full Power Hydraulic

spool diameters, reaction piston diameters, and pedal ratios can be adjusted to suit the required brake pressure and pedal effort specification. Because these systems operate with hydraulic oil, they can be filtered and will provide low maintenance operation. By using a properly sized accumulator, emergency power-off braking that is identical to power-on-braking can be achieved. These systems can be either dedicated or non-dedicated and all seals within the system must be compatible with the fluid medium being used.

These systems will vary in sophistication with the various types of hydraulic systems available today; open center, closed center, and load sensing.

#### Open Center Circuits

Brake application circuits that are used in open center hydraulic systems will contain as a minimum; a hydraulic pump, a relief valve positioned between the pump and an accumulator charging valve, an accumulator, a low pressure warning switch, a brake modulating valve, and the service brakes, see Figures 11 and 12.

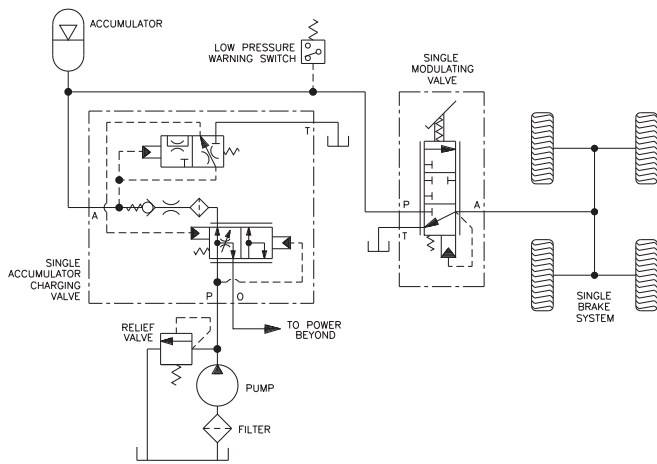

Figure 11 Single Closed Center Brake Circuit in a Non-Dedicated Open Center Hydraulic System

## Operation

In an open center hydraulic system the pump supplies fluid to the accumulator charging valve; either single or dual.

The single accumulator charging valve is used in the open center hydraulic system in conjunction with an accumulator and a modulating brake valve. The charging valve controls the charging rate of the accumulator and the pressure of the fluid in the accumulator. The valve automatically halts charging when the accumulator pressure reaches its high limit.

When the accumulator pressure reaches its low limit, the charging valve diverts a small amount of fluid from the main open center hydraulic system to charge the accumulator. The charging valve charges the accumulator from the open center circuit upon demand and within its preset operating charge rate and maximum pressure. However, in a non-dedicated system if the downstream open center circuit causes the hydraulic system pressure to rise over the high accumulator charge limit, the accumulator will be charged to this higher value.

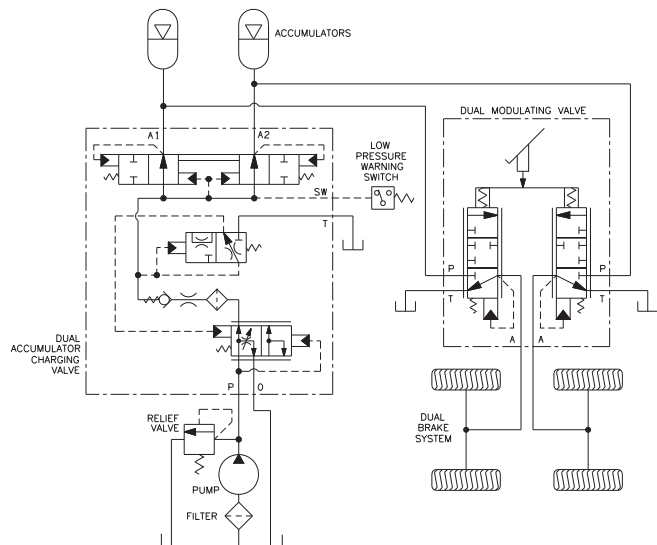

Figure 12 Dual Closed Center Brake Circuit in a Dedicated Open Center Hydraulic System

The dual accumulator charging valve performs essentially the same functions as the single charging valve. When the dual accumulator charging valve is used in a split hydraulic brake system each individual axle is controlled separately by a modulating valve and an accumulator. The charging valve charges both accumulators. The primary advantage of the dual charging valve over the single charging valve is that if half of the brake system fails the remaining half will continue to function.

The charged accumulator supplies pressurized fluid to the closed center brake modulating valve. These can be either single or dual depending on the application. The modulating power brake valves of closed center design are used for modulating output pressures to the brake system.

The fluid remains static at accumulator pressure until the operator depresses the brake pedal. This action causes the brake valve to modulate fluid out to the brakes to provide the braking means. The brake valve will modulate the pressure in the brake system by increasing or decreasing pressure as required in proportion to the input force from the operator via the brake pedal.

Depending on the requirement, these systems can be either single, dual or a variation thereof. This paper will discuss single and dual circuits only to mention the components that differ between the two.

Low pressure warning switches are used to sense accumulator pressure and warn the operator through some audible or visual device in the event the pressure in the accumulator drops to an unsafe operating level.

For these systems there are also governing agencies that regulate the system recovery rate, the number of power-off stops, and operator warning devices.

The full power hydraulic brake system is dependant on accumulated volume and pressure so power-off stopping ability of the system must be considered to assure the operator can stop safely in the event that the engine or pump fails. The number of power-off stops is determined with the pump off. To do this lower the accumulator fluid pressure to the low limit of the accumulator charging valve. Apply the brakes fully and release repeatedly until the point where the accumulator fluid pressure is no longer sufficient to supply adequate pressure to attain the maximum brake line pressure. The number of brake applications between the low limit and maximum brake line pressure is considered the power-off stopping capacity of the system and is regulated by governing agencies.

As an example, the SAE J1473-DEC84 recommendation states that rubber-tired earthmoving machines shall have five full power brake applications with the energy source (pump) disconnected. The capacity of the accumulator(s) shall be sufficient to supply a sixth application of not less than that pressure required to meet the secondary stopping requirements. In addition, the service brake system recovery capacity shall be such that at full engine RPM the service braking system shall have the capability to deliver at least 70% of the pressure measured during the first brake application after the service brakes have been applied twenty times at a rate of six times per minute. This applies to loaders, graders, tractors, and backhoe loaders.

The number of power-off stops can be varied by changing the accumulator size, dry nitrogen precharge, the fluid pressure in the accumulator, or by increasing the pressure differential between the low accumulator charge limit and the maximum brake line pressure required.

Proper consideration must be given when selecting a pump. Most pumps can deliver constant flow and pressure capable of sustaining a full power brake system while rotating at a constant high speed. problems occur when the speeds drop, such as in variable RPM engine driven mobile equipment, to an idle condition.

As the speed drops so does the volume of oil displaced and the efficiency of the pump. At low RPM the pump may be unable to deliver flow at a pressure and an efficiency level capable of reaching the accumulator charging valve high limit. Thus, the accumulator charging valve cannot unload. This causes the pump to get hot and usually results in premature pump failure. It is recommended that pump efficiency be strongly considered when used in this type of system.

While selection of pumps based on high efficiency could lean toward axial or radial piston models, it is not recommended that variable displacement pressure compensated models be selected for use in dedicated brake systems without the use of an accumulator charge valve. In dedicated brake systems the pump supplies only the demands of the brake system. Typically long periods of time can elapse between brake applications. If a pressure compensated pump is used in a closed center circuit without the charge valve, it would then be required to operate destroyed at full compensator pressure for extended periods. This condition has been known to cause heat related pump failure. By using the pressure compensated pump with the accumulator charge valve in an open center circuit the charge valve will unload the pump allowing the pump to displace fluid at low pressure differential.

In the non-dedicated closed center brake system where the pressure compensated pump supplies fluid to both the brake circuit and some secondary requirement, this concern is not so great. The secondary requirement will usually allow the pump to work.

#### The load sensing circuit

Load sensing circuits are very similar to the open center circuits with respect to the required components. In both the open center and load sense brake circuits the accumulator acts as the primary source for brake fluid as well as the power-off braking source of energy. The difference comes in the form of the pump and the charge valve that is used. This type of system will operate as a flow and pressure on demand system. The control section of the load sense accumulator charge valve sends a pilot signal to the pump when fluid is required. Since load sense hydraulic pumps are generally high efficiency piston equipment, the concern over low speed operation is not as great. Again, these circuits can be either single or split, see Figure 13.

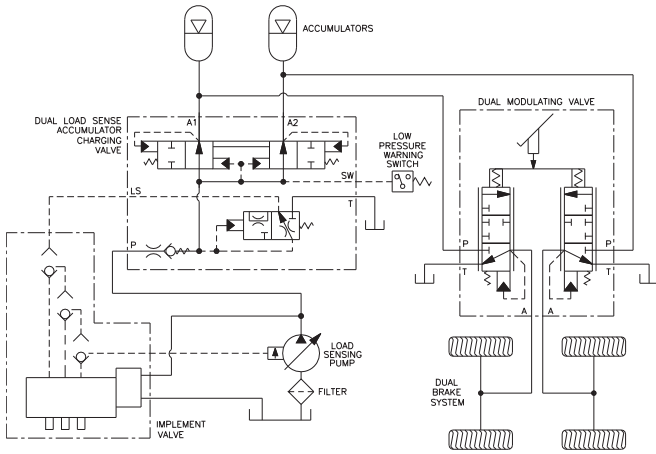

Figure 13 Dual Closed Center Brake Circuit in a Non-Dedicated Load Sense Hydraulic System

The closed center circuits

The full power hydraulic brake circuit that is incorporated in a closed center hydraulic system is usually a non-dedicated circuit. The pressure compensated pump that supplies fluid to the brake system will almost always supply fluid to some other system requirement as well. In these circuits the brakes will operate off of the pump displacement and the accumulators will act as the energy source for the power off braking requirements. It is important in these systems to be sure that the pump can fulfill all of the volume requirements and that the brakes will never suffer a lack of fluid, see Figure 14.

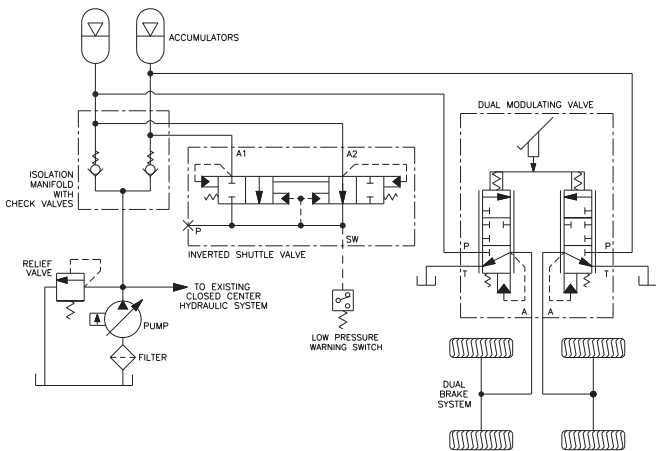

Figure 14 Dual Closed Center Brake Circuit in a Non-Dedicated Closed Center Hydraulic System

**SUMMARY**

Today's brake actuation systems are highly sophisticated and the applications are many and varied. Numerous factors affect the design of these systems, of these operator safety is the most important.

To achieve maximum safety the designer must have a thorough understanding of the components and circuitry. The operating parameters and performance specifications must be carefully analyzed. The reliability of the brake actuation system depends directly upon the quality of the data and the accuracy of the system designer.



**MICO, Incorporated**  
 1911 Lee Boulevard  
 North Mankato, MN U.S.A. 56003-2507  
**Tel:** +1 507 625 6426 **Fax:** +1 507 625 3212

Form No. 80-950-073 1992-07-01